

SPARE PARTS

ViscoTwin

VT104

G7

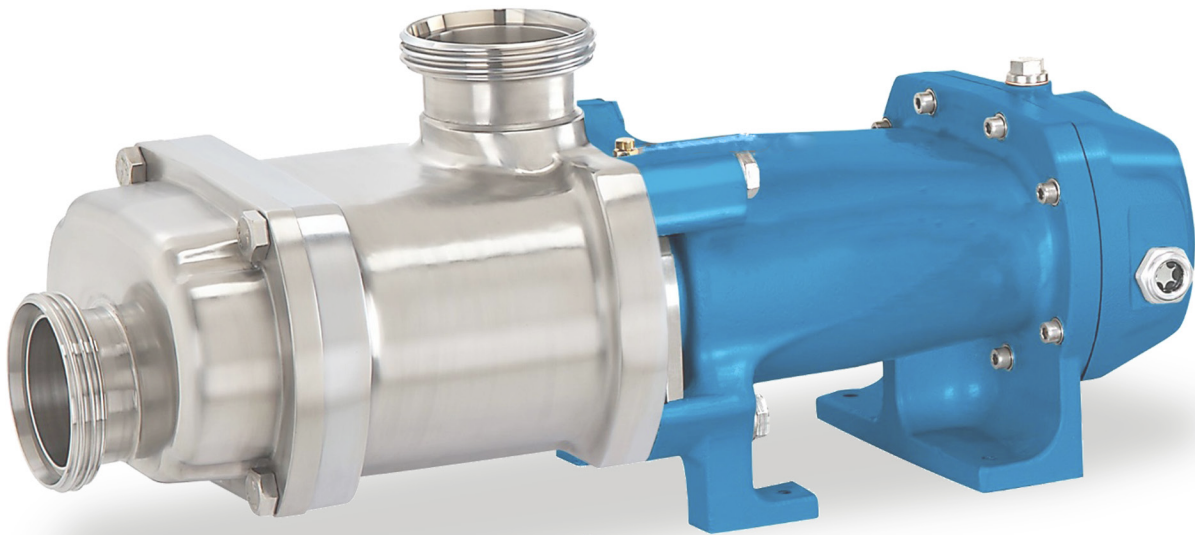

 **PROCESSTEC**
GET TOMORROW'S TECHNOLOGY TODAY

processtec.com
info@processtec.com

9938 W Legacy Ave
Visalia, CA 93291
Phone +1 (559) 429 - 4227
Fax +1 (559) 429 - 4228

1. OVERVIEW DRAWING	3
2. EXPLOSION DRAWING	4
3. TORQUE VALUES.	5
4. SPARE PARTS.	6
4.1 Pump Housing.	6
4.2 Seal Housing	14
4.3 Bearing Housing	24
4.4 Gear Housing.	32
4.5 Drive Train.	41

1. OVERVIEW DRAWING

Industrial Mounting

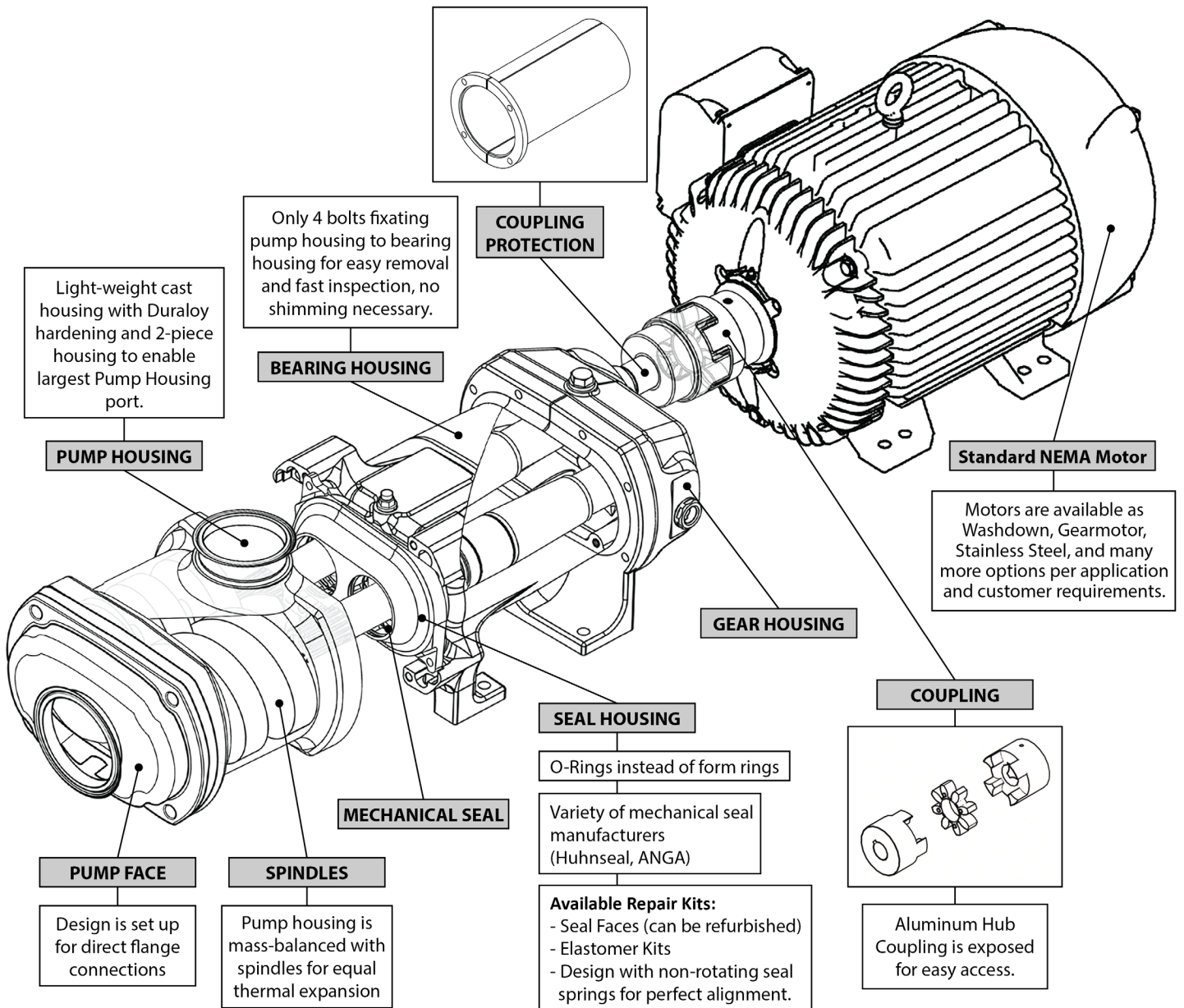

2. EXPLOSION DRAWING

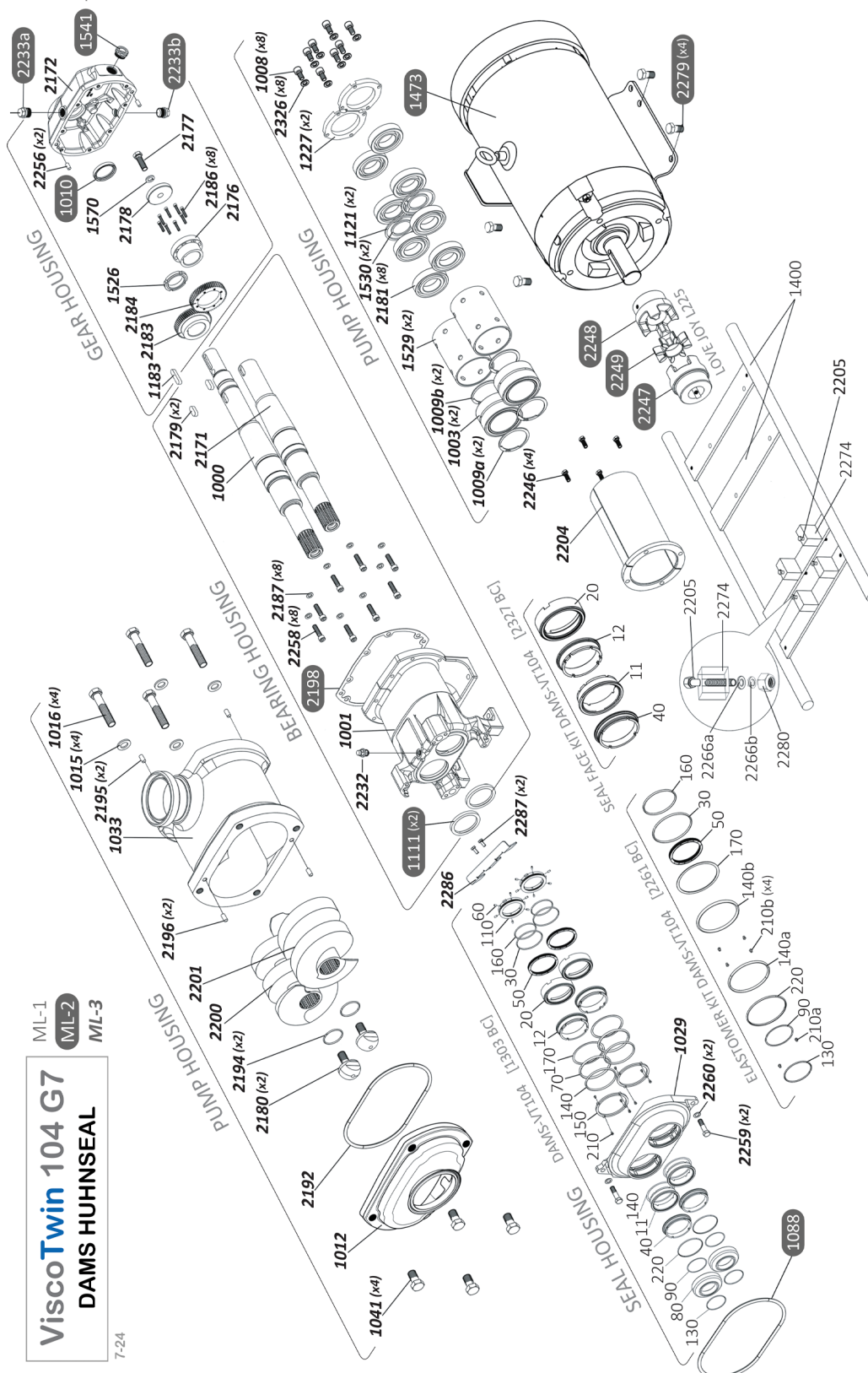

3. TORQUE VALUES

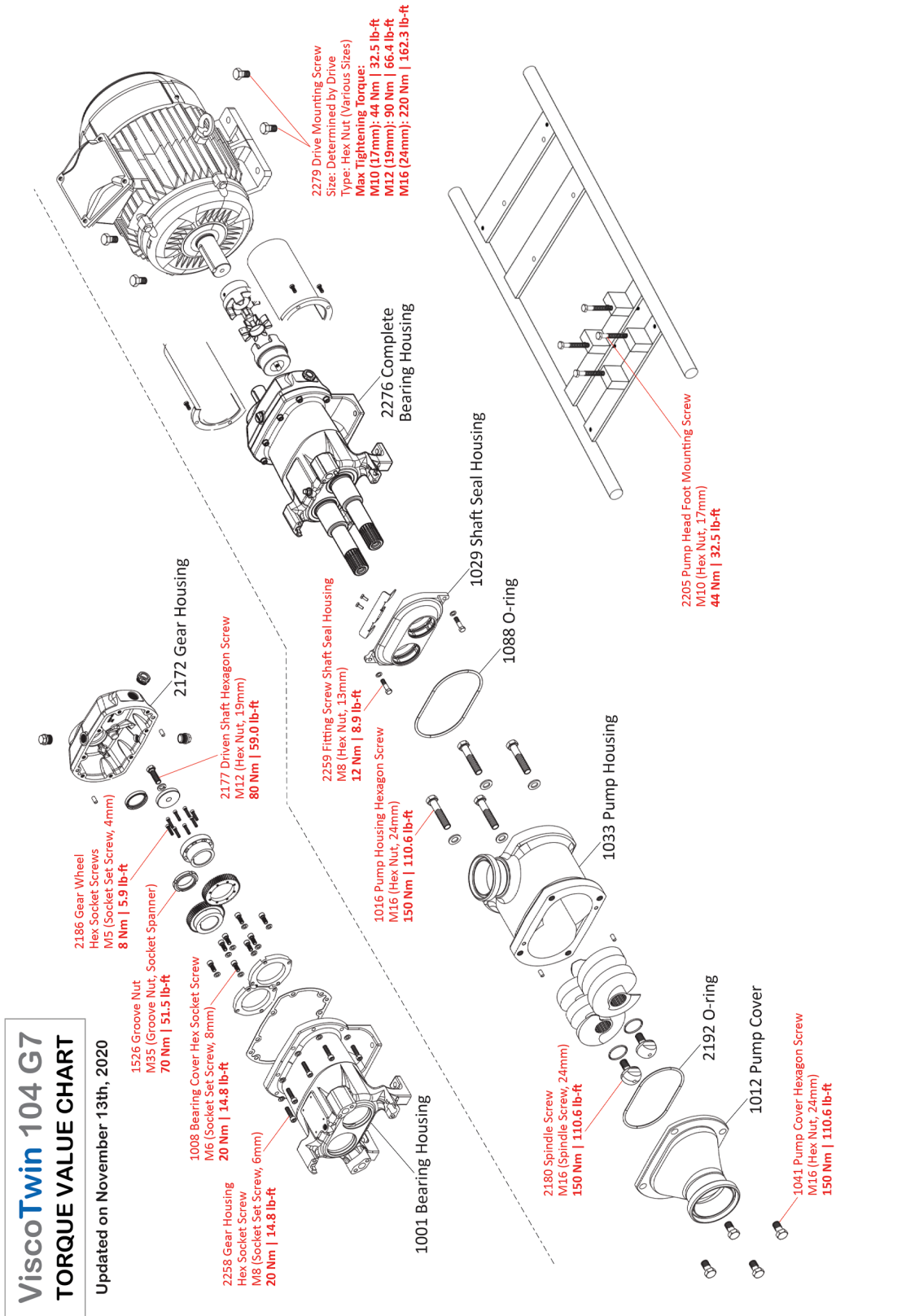

ViscoTwin 104 G7
TORQUE VALUE CHART

Updated on November 13th, 2020





4. SPARE PARTS

4.1 Pump Housing

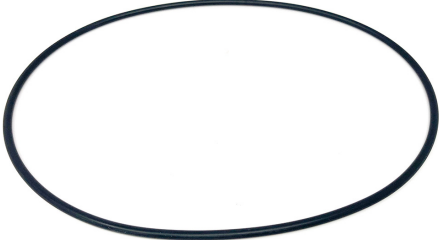
VT104 G7	Spindle Bolt	POS. 2180
PART #	23113	
CUSTOMER REFERENCE #		
MATERIAL	2205	
SPECS	Hex Style	
NOTES	--	

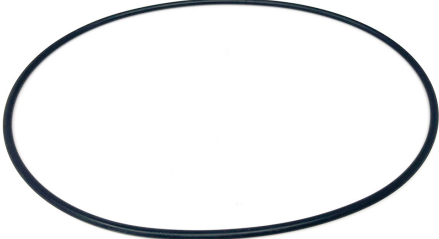
VT104 G7	O-Ring for Pump Face	POS. 2192
PART #	12505	
CUSTOMER REFERENCE #		
MATERIAL	FKM	
SPECS	153.5 x 4mm	
NOTES	--	

VT104 G7	O-Ring for Pump Face	POS. 2192
PART #	12511	
CUSTOMER REFERENCE #		
MATERIAL	EPDM	
SPECS	153.5 x 4mm	
NOTES	--	

VT104 G7	O-Ring for Spindle Bolt	POS. 2194
PART #	12504	
CUSTOMER REFERENCE #		
MATERIAL	FKM	
SPECS	42 x 3mm	
NOTES	--	

VT104 G7	O-Ring for Spindle Bolt	POS. 2194
PART #	12510	
CUSTOMER REFERENCE #		
MATERIAL	EPDM	
SPECS	42 x 3mm	
NOTES	--	

VT104 G7	Dowel Pin for Pump Face & Housing	POS. 2195, 2196
PART #	8385	
CUSTOMER REFERENCE #		
MATERIAL	316L	
SPECS	8mm/16mm	
NOTES	--	

VT104 G7	Spindle Pair VT104.27	POS. 2202
PART #	12639	
CUSTOMER REFERENCE #		
MATERIAL	316L	
SPECS	27mm, hardened	
NOTES		

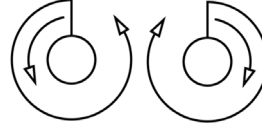
VT104 G7	Spindle Pair VT104.36	POS. 2202
PART #	18489	
CUSTOMER REFERENCE #		
MATERIAL	316L	
SPECS	36mm, hardened	
NOTES		

VT104 G7	Spindle Pair VT104.53	POS. 2202
PART #	17516	
CUSTOMER REFERENCE #		
MATERIAL	316L	
SPECS	53mm, hardened	
NOTES		

VT104 G7	Pump Face OD3"	POS. 1012
PART #	19158	
CUSTOMER REFERENCE #		
MATERIAL	316Ti	
SPECS	PF:OD3", Tri-Clamp	
NOTES	--	

VT104 G7	Pump Face OD4"	POS. 1012
PART #	19357	
CUSTOMER REFERENCE #		
MATERIAL	316Ti	
SPECS	PF:OD4", Tri-Clamp	
NOTES	--	

VT104 G7	Hex Head Cap Screw for Pump Face	POS. 1041
PART #	19358	
CUSTOMER REFERENCE #		
MATERIAL	A2-70	
SPECS	ISO4017 - M16 x 30mm	
NOTES	--	

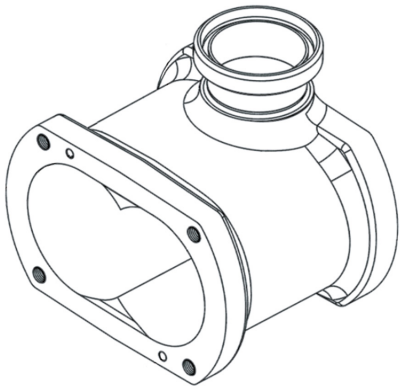
VT104 G7	Pump Housing OD2"	POS. 1033
PART #	19380	
CUSTOMER REFERENCE #		
MATERIAL	316L	
SPECS	PCP:OD2" Tri-Clamp	
NOTES	--	

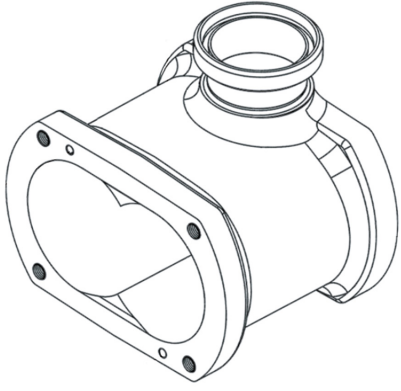
VT104 G7	Pump Housing OD2 1/2"	POS. 1033
PART #	19379	
CUSTOMER REFERENCE #		
MATERIAL	316L	
SPECS	PCP:OD2-1/2" Tri-Clamp	
NOTES	--	

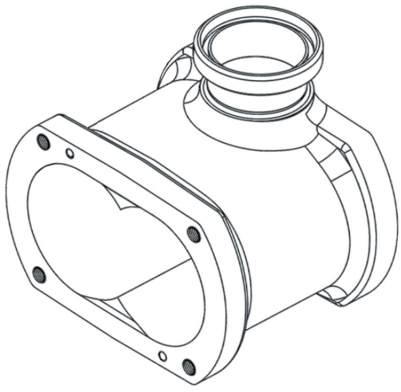
VT104 G7	Pump Housing OD3"	POS. 1033
PART #	19157	
CUSTOMER REFERENCE #		
MATERIAL	316L	
SPECS	PCP:OD3" Tri-Clamp	
NOTES	--	

4.2 Seal Housing

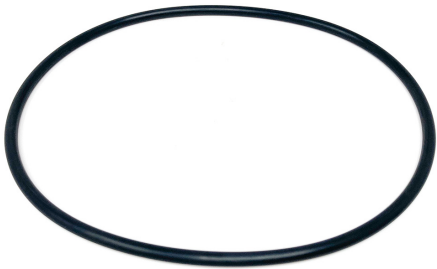
VT104 G7	O-Ring Seal Housing	POS. 1088
PART #	12503	
CUSTOMER REFERENCE #		
MATERIAL	FKM	
SPECS	142 x 6.2mm	
NOTES	--	

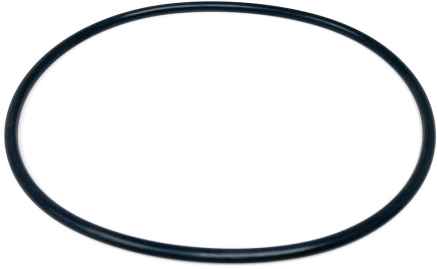
VT104 G7	O-Ring Seal Housing	POS. 1088
PART #	12512	
CUSTOMER REFERENCE #		
MATERIAL	EPDM	
SPECS	142 x 6.2mm	
NOTES	--	

VT104 G7	Elastomer Kit SAMS	POS. 2261 BF
PART #	12367	
CUSTOMER REFERENCE #		
MATERIAL	FKM	
SPECS	HUHNSEAL, SD: 45mm	
NOTES	--	

VT104 G7	Elastomer Kit SAMS	POS. 2261 BF
PART #	12368	
CUSTOMER REFERENCE #		
MATERIAL	EPDM	
SPECS	HUHNSEAL, SD: 45mm	
NOTES	--	

VT104 G7	Elastomer Kit DAMS	POS. 2261 BC
PART #	12521	
CUSTOMER REFERENCE #		
MATERIAL	FKM	
SPECS	HUHNSEAL, SD: 45mm	
NOTES	--	

VT104 G7	Elastomer Kit DAMS	POS. 2261 BC
PART #	12522	
CUSTOMER REFERENCE #		
MATERIAL	EPDM	
SPECS	HUHNSEAL, SD: 45mm	
NOTES	--	

VT104 G7	Mechanical Seal SAMS	POS. 1303 BF
PART #	11458	
CUSTOMER REFERENCE #		
MATERIAL	316Ti/SiC, FKM	
SPECS	HUHNSEAL, SD: 45mm	
NOTES	--	

VT104 G7	Mechanical Seal DAMS	POS. 1303 BF
PART #	12359	
CUSTOMER REFERENCE #		
MATERIAL	316Ti/SiC, EPDM	
SPECS	HUHNSEAL, SD: 45mm	
NOTES	--	

VT104 G7	Mechanical Seal SAMS	POS. 1303 BF
PART #	12360	
CUSTOMER REFERENCE #		
MATERIAL	316Ti/TuC, FKM	
SPECS	HUHNSEAL, SD: 45mm	
NOTES	--	

VT104 G7	Mechanical Seal SAMS	POS. 1303 BF
PART #	12362	
CUSTOMER REFERENCE #		
MATERIAL	316Ti/TuCKE, EPDM	
SPECS	HUHNSEAL, SD: 45mm	
NOTES	--	

VT104 G7	Mechanical Seal SAMS	POS. 1303 BF
PART #	12361	
CUSTOMER REFERENCE #		
MATERIAL	316Ti/TuC, EPDM	
SPECS	HUHNSEAL, SD: 45mm	
NOTES	--	

VT104 G7	Mechanical Seal DAMS	POS. 1303 BC
PART #	5012	
CUSTOMER REFERENCE #		
MATERIAL	316Ti/SiC, FKM	
SPECS	HUHNSEAL, SD: 45mm	
NOTES	--	

VT104 G7	Mechanical Seal DAMS	POS. 1303 BC
PART #	19279	
CUSTOMER REFERENCE #		
MATERIAL	316Ti/SiC, EPDM	
SPECS	HUHNSEAL, SD: 45mm	
NOTES	--	

VT104 G7	Mechanical Seal DAMS	POS. 1303 BC
PART #	12363	
CUSTOMER REFERENCE #		
MATERIAL	316Ti/TuC, FKM	
SPECS	HUHNSEAL, SD: 45mm	
NOTES	--	

VT104 G7	Mechanical Seal DAMS	POS. 1303 BC
PART #	11440	
CUSTOMER REFERENCE #		
MATERIAL	316Ti/TuC, EPDM	
SPECS	HUHNSEAL, SD: 45mm	
NOTES	--	

VT104 G7	Seal Housing	POS. 1029
PART #	19472	
CUSTOMER REFERENCE #		
MATERIAL	316L	
SPECS	--	
NOTES	--	

VT104 G7	Hex Socket Screw for Seal Housing	POS. 2259
PART #	19098	
CUSTOMER REFERENCE #		
MATERIAL	SS	
SPECS	M8 x 35mm	
NOTES	--	

VT104 G7	Protection Shield	POS. 2286
PART #	19368	
CUSTOMER REFERENCE #		
MATERIAL	SS	
SPECS	--	
NOTES	--	

VT104 G7	Hex Bolt for Protection Shield	POS. 2287
PART #	22444	
CUSTOMER REFERENCE #		
MATERIAL	SS	
SPECS	--	
NOTES	--	

4.3 Bearing Housing

VT104 G7	Key for Coupling	POS. 1183
PART #	12618	
CUSTOMER REFERENCE #		
MATERIAL	304	
SPECS	DIN6885 - 8 x 7 x 32mm, with M3 thread	
NOTES	--	

VT104 G7	Shaft Sealing Ring Bearing Housing	POS. 1111
PART #	12529	
CUSTOMER REFERENCE #		
MATERIAL	FKM	
SPECS	DIN3760-AS - 50 x 72 x 8mm	
NOTES	--	

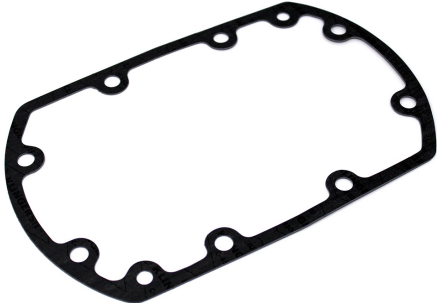
VT104 G7	Flat Gasket Gear Housing	POS. 2198
PART #	12492	
CUSTOMER REFERENCE #		
MATERIAL	--	
SPECS	1mm	
NOTES	--	

VT104 G7	Drive Shaft	POS. 1000
PART #	19091	
CUSTOMER REFERENCE #		
MATERIAL	316	
SPECS	--	
NOTES	--	

VT104 G7	Driven Shaft	POS. 2171
PART #	19093	
CUSTOMER REFERENCE #		
MATERIAL	316	
SPECS	--	
NOTES	--	

VT104 G7	Bearing Housing	POS. 1001
PART #	19347	
CUSTOMER REFERENCE #		
MATERIAL	SS	
SPECS	Stainless steel cast	
NOTES	--	

VT104 G7	Needle Roller Bearing	POS. 1003
PART #	23503	
CUSTOMER REFERENCE #		
MATERIAL	--	
SPECS	--	
NOTES	--	

VT104 G7	Lock Snap Ring	POS. 1009 a, b
PART #	19316	
CUSTOMER REFERENCE #		
MATERIAL	1.0503	
SPECS	Spring steel	
NOTES	--	

VT104 G7	Hex Head Cap Screw for Pump Housing	POS. 1016
PART #	23842	
CUSTOMER REFERENCE #		
MATERIAL	A2-70	
SPECS	ISO4017-M16 x 85mm, Wrench 24mm	
NOTES	--	

VT104 G7	Hex Socket Screw for Gear Housing	POS. 2258
PART #	23843	
CUSTOMER REFERENCE #		
MATERIAL	A2-70	
SPECS	DIN912, M8 x 20mm	
NOTES	--	

VT104 G7	Outer Spacer Ring for Ball Bearings	POS. 1121
PART #	12539	
CUSTOMER REFERENCE #	29029	
MATERIAL	SS	
SPECS	outside	
NOTES	--	

VT104 G7	Inner Spacer Ring for Ball Bearing	POS. 1530
PART #	12540	
CUSTOMER REFERENCE #	29028	
MATERIAL	SS	
SPECS	inside	
NOTES	--	

VT104 G7	Spacer Sleeve for Bearings	POS. 1529
PART #	19322	
CUSTOMER REFERENCE #		
MATERIAL	SS	
SPECS	--	
NOTES	--	

VT104 G7	Angular Ball Bearing	POS. 2181
PART #	21963	
CUSTOMER REFERENCE #		
MATERIAL	--	
SPECS	--	
NOTES	--	

VT104 G7	Key for Gear Wheels	POS. 2179
PART #	23343	
CUSTOMER REFERENCE #		
MATERIAL	SS	
SPECS	--	
NOTES	--	

VT104 G7	Venting Valve	POS. 2232
PART #	18757	
CUSTOMER REFERENCE #		
MATERIAL	304	
SPECS	1/4"	
NOTES	--	

4.4 Gear Housing

VT104 G7	Shaft Sealing Ring Gear Housing	POS. 1010
PART #	12530	
CUSTOMER REFERENCE #		
MATERIAL	FKM	
SPECS	DIN3760-AS, 32 x 45 x 8mm	
NOTES	--	

VT104 G7	Magnetic Screw Plug	POS. 2233
PART #	18756	
CUSTOMER REFERENCE #		
MATERIAL	Aluminium	
SPECS	1/2"	
NOTES	--	

VT104 G7	Oil Level Sight Gauge	POS. 1541
PART #	21766	
CUSTOMER REFERENCE #		
MATERIAL	--	
SPECS	G3/4"	
NOTES	--	

VT104 G7	Gasket for Oil Level Sight Gauge	POS. 1541 a
PART #	23665	
CUSTOMER REFERENCE #		
MATERIAL	FKM	
SPECS	Gasket for Oil Level Sight Gauge	
NOTES	In set of 5 only	

VT104 G7	Gear Oil Bearing Housing VT	POS. 2170
PART #	21871	
CUSTOMER REFERENCE #		
MATERIAL	--	
SPECS	1 L, foodgrade	
NOTES	--	

VT104 G7	Hex Socket Screw for Bearing Cover	POS. 1008
PART #	19341	
CUSTOMER REFERENCE #		
MATERIAL	Steel 10.9	
SPECS	DIN6912 - M8 x 25mm, B=22mm, Low profile socket head	
NOTES	--	

VT104 G7	Bearing Cover	POS. 1227
PART #	19096	
CUSTOMER REFERENCE #		
MATERIAL	C45	
SPECS	--	
NOTES	--	

VT104 G7	Gear Wheel Nut for Drive Shaft	POS. 1526
PART #	19320	
CUSTOMER REFERENCE #		
MATERIAL	SS	
SPECS	--	
NOTES	--	

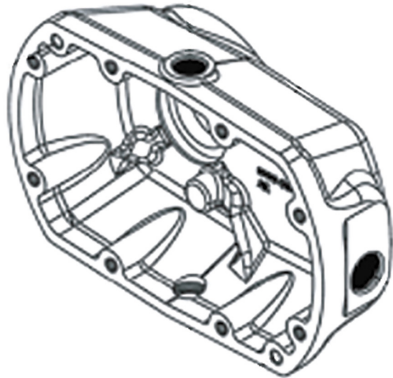
VT104 G7	Gear Housing	POS. 2172
PART #	19414	
CUSTOMER REFERENCE #		
MATERIAL	SS	
SPECS	--	
NOTES	--	

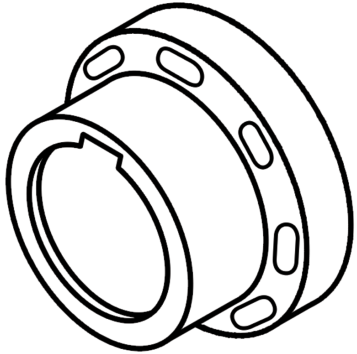
VT104 G7	Gear Wheel Collar Driven Shaft	POS. 2176
PART #	19327	
CUSTOMER REFERENCE #		
MATERIAL	--	
SPECS	--	
NOTES	--	

VT104 G7	Hex Bolt for Driven Shaft	POS. 2177
PART #	19310	
CUSTOMER REFERENCE #		
MATERIAL	Steel 10.9	
SPECS	ISO4017 - M12 x 40mm	
NOTES	--	

VT104 G7	Press Ring Gear Wheel Driven Shaft	POS. 2178
PART #	19333	
CUSTOMER REFERENCE #		
MATERIAL	304	
SPECS	--	
NOTES	--	

VT104 G7	Gear Wheel Drive Shaft	POS. 2183
PART #	12611	
CUSTOMER REFERENCE #		
MATERIAL	AISI 5115, hardened	
SPECS	49 teeth, b=16mm, module 1,5	
NOTES	--	

VT104 G7	Gear Wheel Driven Shaft	POS. 2184
PART #	12610	
CUSTOMER REFERENCE #		
MATERIAL	AISI 5115, hardened	
SPECS	49 teeth, B=16mm, module 1,5	
NOTES	--	

VT104 G7	Hex Socket Screw for Gear Synchronization Lock Ring	POS. 2186
PART #	18782	
CUSTOMER REFERENCE #		
MATERIAL	Steel 12.9	
SPECS	DIN912, M5 x 25mm	
NOTES	--	

VT104 G7	Dowel Pin for Gear Housing	POS. 2256
PART #	18764	
CUSTOMER REFERENCE #		
MATERIAL	303	
SPECS	DIN7 - 8m6 x 20mm, undersize	
NOTES	--	

VT104 G7	Lock Washer for Bearing Cover Screw	POS. 2326
PART #	19081	
CUSTOMER REFERENCE #		
MATERIAL	--	
SPECS	--	
NOTES	--	

4.5 Drive Train

VT104 G7	Pump Hub 42/55 SIT	POS. 2247
PART #	21702	
CUSTOMER REFERENCE #		
MATERIAL	Aluminium	
SPECS	SIT, BS:28mm	
NOTES	--	

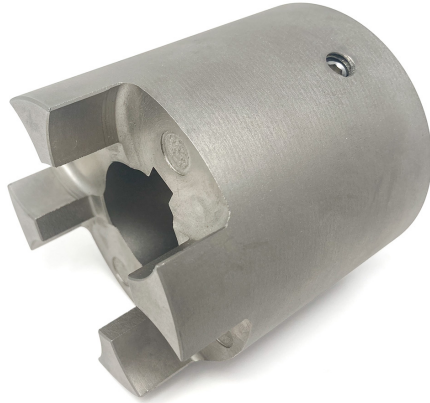
VT104 G7	Motor Hub 42/55 NEMA 21X	POS. 2248
PART #	21704	
CUSTOMER REFERENCE #		
MATERIAL	Aluminium	
SPECS	SIT, BS:1-3/8"	
NOTES	--	

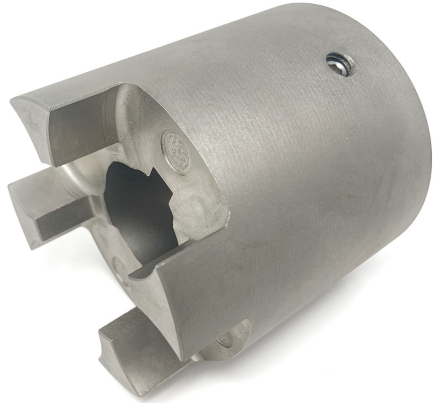
VT104 G7	Motor Hub 42/55 NEMA 25X	POS. 2248
PART #	21705	
CUSTOMER REFERENCE #		
MATERIAL	Aluminium	
SPECS	SIT, BS:1-5/8"	
NOTES	--	

VT104 G7	Motor Hub 42/55 NEMA 28X	POS. 2248
PART #	21706	
CUSTOMER REFERENCE #		
MATERIAL	Aluminium	
SPECS	SIT, BS:1-7/8"	
NOTES	--	

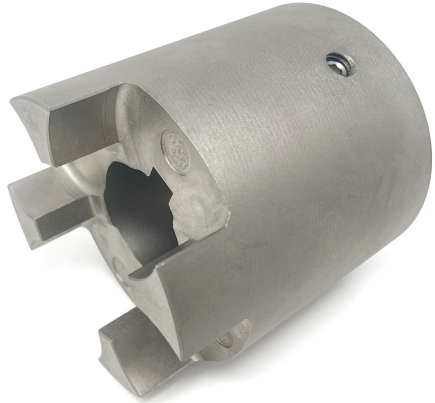
VT104 G7	Motor Hub 42/55 NEMA 32X	POS. 2248
PART #	21707	
CUSTOMER REFERENCE #		
MATERIAL	Aluminium	
SPECS	SIT, BS:2-1/8"	
NOTES	--	

VT104 G7	Coupling Spider 42/55 Red	POS. 2249
PART #	7115	
CUSTOMER REFERENCE #		
MATERIAL	PU	
SPECS	SIT, 98 42/55 - red	
NOTES	--	

VT104 G7	W22 Severe Duty Motor	POS. 3003
PART #	various	
CUSTOMER REFERENCE #		
MATERIAL	variable	
SPECS	variable	
NOTES	--	